

# **OTMT**

## **DIGITAL READOUT KIT**

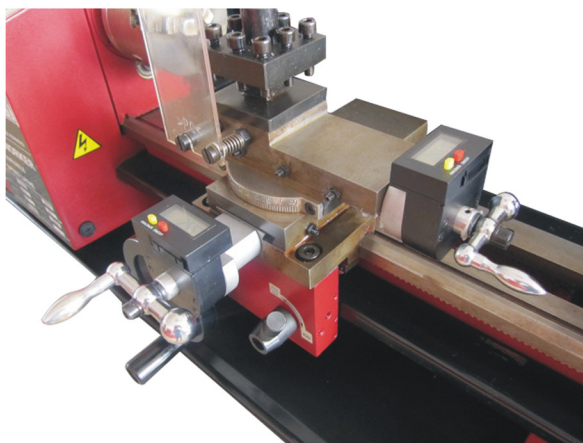

<b>ITEM NO.</b>	<b>MODEL NO.</b>
<b>87-115-960</b>	<b>10292</b>
<b>87-116-024</b>	<b>10293</b>
<b>87-115-965</b>	<b>10294</b>

Version date: 11/23/2016

Please Read These Instructions Before Operating Your Machine  
Contents Subject To Change Without Notice

Please note this guide applies to C2, SC2, C3, C4, C6 mini lathe only.

# CONTENTS

<b>The Complete Set Of Drcd Kit (digital Readout For Cutting Depth).....</b>	<b>1</b>
<b>Assembly On Cross Slide.....</b>	<b>2</b>
<b>Assembly On Compound Slide.....</b>	<b>3</b>
<b>The Completed Drcd Kit.....</b>	<b>4</b>
<b>Parts Breakdown &amp; Parts List.....</b>	<b>4</b>

## THE COMPLETE SET OF DRCD KIT

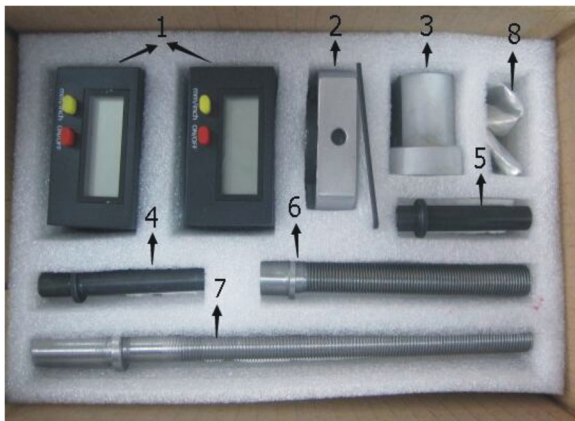

Part #	Description
1	Digital Readout Box
2	Bracket For The Compound Slide
3	Bracket For The Cross Slide
4	Transition Shaft For The Cross Slide
5	Transition Shaft For The Compound Slide
6	Compound Feed Screw
7	Cross Slide Feed Screw
8	Screws Package

## ASSEMBLY ON CROSS SLIDE

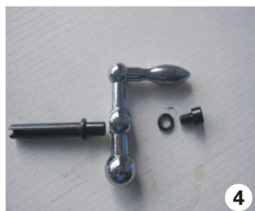
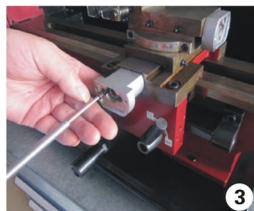
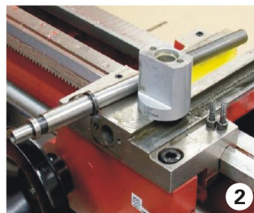

1. Remove the screw securing the cross slide handle. Remove the ball handle, spacer and dial.
2. Remove the dial bracket, and take out the cross slide feed screw.
3. Assemble the new cross slide feed screw (Part No.7), bracket (Part No.3) step by step. Tighten the two M4 × 12 screws.
4. Assemble the transition shaft (Part No.4) onto the dismantled ball handle.
5. Assemble the digital readout box(Part No.1) onto the bracket, then fitted the assembled transition shaft and ball handle into the lead screw. Slightly adjust the transition shaft to make it work well with the leadscrew. Finally tightened with two M3 × 25 screws (Part No.8).
6. Make the final adjustment for free movement of handle with little drag. Lock the small screws.



## ASSEMBLY ON COMPOUND SLIDE

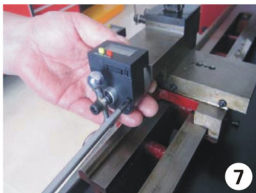
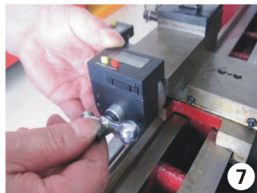

1. Remove the screw securing the compound handle. Remove the ball handle, spacer and dial.
2. Loosen the screws. Remove the dial bracket, and take out the compound feed screw.
3. Assemble the block (Part No.8) and compound feed screw (Part No.6) on the bracket (Part No.2).
4. Assemble the transition shaft (Part No.5) onto the dismantled ball handle.
5. Use the transition shaft to push the assembled compound feed screw and bracket part into the compound slide.
6. Then refit the dismantled original two M4 × 12 screws. After that, taking out the transition shaft waiting for assembling the digital readout box.
7. Assemble the digital readout box (Part No.1) onto the bracket, then fitted the assembled transition shaft and ball handle into the lead screw. Slightly adjust the transition shaft to make it work well with the lead screw. Finally tightened with two M3 × 25 screws (Part No.8).
8. Make the final adjustment for free movement of handle with little drag. Lock the small screws.



Part No.	Specification	Description	Quantities	Note
1	C2A05E02	Cross Slide Feed Screw	1	
2	GB 879-86 2.5 × 5	Elastic Pin 2.5 × 5	1	
3	C2A05E033	Bracket	1	
4	ZCG1.0	Digital Readout Box	1	
5	GB77-85 M3 × 3	Hex Screw M3 × 3	1	
6	GB819-85 M3 × 25	Cross Head Screw M3 × 25	2	
7	GB70-85 M4 × 12	Hex Screw M4 × 12	2	
8	GB93-87 M6	Spring Washer	1	Dismantle from machine
9	C2A05E01	Transition Shaft	1	
10	C2A0511	Ball Handle	1	Dismantle from machine
11	GB70-85 M6 × 10	Hex Screw M6 × 10	1	Dismantle from machine

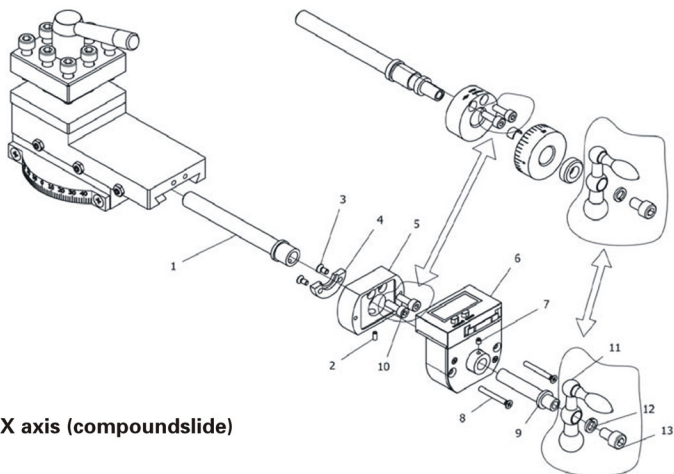

### X axis (compoundslide)

Part No.	Specification	Description	Quantities	Note
1	C2A04D04	Compound slide feed screw	1	
2	GB 879-86 2.5 × 5	Elastic pin 2.5 × 5	1	
3	GB819-85 M3 × 6	Cross head screw M3 × 6	2	
4	C2A04D01	Block	1	
5	C2A04D03	Bracket	1	
6	ZCG1.0	Digital readout box	1	
7	GB77-85 M3 × 3	Hex screw M3 × 3	1	
8	GB819-85 M3 × 25	Cross head screw M3 × 25	2	
9	C2A04D02	Transition shaft	1	
10	GB70-85 M4 × 12	Hex screw M4 × 12	2	Dismantle from machine
11	C2A0411	Ball handle	1	Dismantle from machine
12	GB93-87 M6	Spring washer	1	Dismantle from machine
13	GB70-85 M6 × 10	Hex screw M6 × 10	1	Dismantle from machine

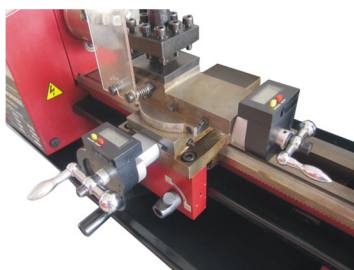

**OTMT**